

ISUZU

SPECIFICATIONS

FSR 140/120-260

FSD 140/120-260

Now with
Sat Nav fitted
as standard*



* Satellite Navigation functions and maps provided at no extra cost, with up to four quarterly updates provided by user free download for the first three years of ownership, after which updates can be purchased at additional cost.

AUSTRALIA'S TOP SELLING TRUCK BRAND SINCE 1989.

AT A GLANCE*

GVM	14,000 / 12,000 kg
GCM	20,000 kg
Power	191 kW @ 2,400 rpm
Torque	761 Nm @ 1,450 - 2,400 rpm

* Refer to back page for detailed weight rating information

ADVANCED TECHNOLOGY

Emissions: Euro V / ADR 80/03	Hill Start Aid (HSA) - except auto model
Driver and passenger airbag with seatbelt pretensioner	Electric mirrors
ADR42 compliant sleeper	Front stabiliser bar
ECE-R29 compliant cab	Cruise control
Anti-lock Braking System (ABS)	ISRI 6860 seat with integrated seatbelt
Anti Skid Regulator (ASR) - except auto model	Cornering lamps



We
share
the
load.

ISUZU
RELIABILITY IS EVERYTHING

DRIVELINE AND CHASSIS SPECIFICATIONS

ENGINE: ISUZU 6HK1-TCC

- Type:** 6 cylinder 24 valve SOHC
Displacement: 7,790 cc
Compression Ratio: 17.5:1
Bore x Stroke: 115 mm x 125 mm
Max power (DIN-NET): 191 kW (256 HP) @ 2,400 RPM
(JIS Gross): 198 kW (265 HP) @ 2,400 RPM
Max torque (DIN-NET): 761 Nm (561 lb.ft) @ 1,450 - 2,400 RPM
(JIS Gross): 788 Nm (581 lb.ft) @ 1,450 - 2,400 RPM
Induction system: Electronically controlled variable nozzle turbocharger with air-to-air intercooler.
Fuel injection: Direct injection high pressure common rail system.
Emission control system: Cooled EGR with exhaust Diesel Particulate Diffuser (DPD). ADR 80/03 (Euro V) compliant. EEV compliant.

CLUTCH (MANUAL TRANSMISSION MODEL)

- Air assisted hydraulic control. Single plate 381 mm diameter.
- Total lining area: 1,363 cm²

TRANSMISSION

ISUZU MZW-6P (except auto model)

- 6 speed manual with air assisted shift.
 - Synchromesh on gears 2-6. Triple cone synchromesh on 2nd and 3rd gears. Integral oil pump provides full pressure lubrication.
 - PTO provision on LHS of transmission case. PTO drive from mainshaft gear.
 - Gear ratios (:1)
- | 1st | 2nd | 3rd | 4th | 5th | 6th | Rev |
|-------|-------|-------|-------|-------|-------|-------|
| 6.615 | 4.095 | 2.358 | 1.531 | 1.000 | 0.722 | 6.615 |

ALLISON LCT2500 (auto model)

- 6 speed automatic. 5th generation electronic controls with adaptive shift.
 - Allison long life TranSynd synthetic fluid.
 - LHS and RHS PTO openings on transmission case. Torque convertor turbine driven PTO drive gear.
 - Gear ratios (:1)
- | 1st | 2nd | 3rd | 4th | 5th | 6th | Rev |
|------|------|------|------|------|------|------|
| 3.51 | 1.90 | 1.44 | 1.00 | 0.74 | 0.64 | 5.09 |

AXLES

Front: Isuzu F050

- Reverse Elliot I-beam. 5,000 kg capacity.

Rear: Isuzu R090

- Full floating Banjo type. 9,000 kg capacity.
- Drive ratio: 4.555:1 (manual model), 5.125:1 (auto model).

SUSPENSION

Front:

- Single stage alloy steel taper-leaf springs.
- Double acting hydraulic shock absorbers. Stabiliser bar.

Rear (FSR 140/120-260):

- Multi-leaf main spring, multi leaf helper spring.

Rear (FSD 140/120-260):

- Hendrickson HAS200 airbag. 9,000 kg capacity at ground.
- Outboard mounted double acting shock absorbers.

BRAKES

- Dual circuit air over hydraulic front and rear drum brakes.
- ABS.

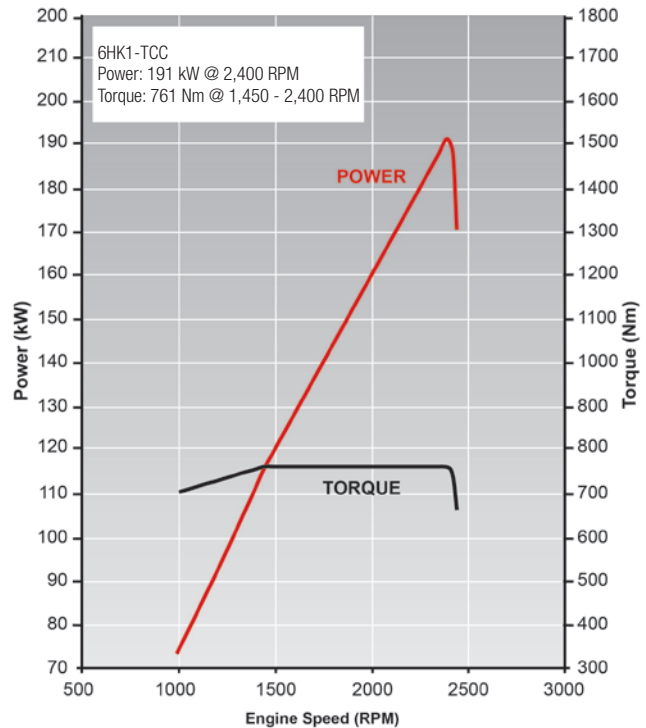

- ASR traction control - except auto model.
- Hill Start Aid (HSA) - except auto model.
- Front drum size: 370 x 150 mm
- Rear drum size: 370 x 150 mm
- Spring park brake.
- Air controlled exhaust brake.
- Air dryer.

STEERING

- Power assisted recirculating ball steering.
- Gear ratio: 16:1 - 18.8:1
- Turns lock to lock: 4.1
- Maximum angle: 44° (inside wheel) / 34° (outside wheel)

WHEELS AND TYRES

- 19.5 x 6.75 eight stud ISO standard steel wheels (except AW model).
- 19.5 x 6.75 eight stud ISO standard Alcoa aluminium wheels (AW model).
- 265/70R19.5 140/138M Michelin X Multi Z Tubeless.
- Maximum tyre rating:
 - Steer axle: 5,000 kg
 - Drive axle: 9,440 kg
- Spare wheel and tyre assembly with winch type carrier.

CHASSIS FRAME

- Cold rivetted ladder frame with parallel side rails. HT540A high tensile weldable steel sidemembers.
- Frame dimensions:
 - Side rail (mm): 225 x 70 x 6.0
 - Rear frame width (mm): 840

FUEL TANK

- Frame mounted 200L steel fuel tank.
- Lockable fuel cap.

ELECTRICAL SYSTEM

- 24 volt electrical system.
- 90 amp alternator.
- 24 volt, 5.0 kW starter motor.
- 2 x 115E41L (651 CCA) batteries connected in series.
- Underdash CAN interface unit and connector. SAE J1939 protocol. Facilitates connection to a Fleet Management System (FMS) (not supplied).

CABIN SPECIFICATIONS AND APPOINTMENTS

CAB EXTERIOR

- All steel construction. High tensile steel used for cab underframe. Manual cab tilt to 45° with torsion bar assistance.
- Complies with ECE-R29 cab strength standard.
- Liquid filled front and rear cab mounts.
- Heavy duty non slip entry steps.
- 90° opening internally reinforced front doors.
- Water spray suppression guards and front mudflaps.
- Laminated windscreen with shade band.
- Two speed windscreen wipers with intermittent wipe mode.
- Halogen multi-reflector headlamps incorporating turn signals. Additional door mounted integrated side indicator/cornering lamps.
- Combination brake, turn, reverse and marker lamps, registration plate illumination lamps. Extended wiring harness. Reverse alarm.
- Roof-mounted clearance lamps.
- Heated and powered exterior main mirrors with flat glass and additional powered convex "spot" mirrors.
- Chrome grille.
- FUPD underun bar - complies with ECE R93.
- Body coloured steel air dam bumper with front foglamps.

CAB INTERIOR

- Isri 6860 air suspension driver's seat with pneumatic lumbar support, height, rake and automatic weight adjustment.
- Front passenger adjustable bucket seat and front centre seat with folding seat back.
- 3-point lap sash seatbelts in all outboard seating positions. Driver seatbelt with pretensioner integrated with driver seat. Outboard front passenger seatbelt fitted with pretensioner. Centre seat lap belts.
- ADR42 compliant sleeper.
- Driver and outboard front passenger airbag.
- Door and roof pillar entry assist grips.
- Full interior trim, padded roof lining and vinyl floor covering. Driver and passenger windscreen header storage shelf.
- Tilt/Telescopic adjustable steering column, soft feel urethane steering wheel.
- Electric windows.
- Central locking with remote keyless entry and immobiliser.
- Twin cup holders. 24V cigarette lighter. Dashboard hook.
- Front door mounted storage pockets and driver's side ashtray.
- Centre console box with storage tray. Fold down storage tray behind centre seat backrest.
- Fully integrated auto control air conditioning and heater/demister with 4-speed fan and outlets for windscreen, side windows, face and floor.
- Fluorescent type interior lamp with On/Door/Off switch.
- 2 DIN, two speaker radio/CD/DVD Digital Audio Visual Entertainment (DAVE) unit with 6.2" LCD touch screen DAB+ digital radio and fully integrated Bluetooth with voice recognition. 4GB internal storage for music files. USB/SD card and auxiliary input connection provisions.
- DIN sized compartment for storage or for CB radio installation.

ISUZU SATELLITE NAVIGATION

Integrated with radio/CD multimedia unit. Displayed information includes:

- Points of interest and Isuzu truck dealer locations.
- Road safety alerts.
- Speed limits and traffic signals.
- Route selection based on entered information such as vehicle weight and dimensions.

DRIVER CONTROLS

- Key-operated engine start/stop and steering lock. Engine idle speed control.
- HSA slow/fast engagement control and on/off switch - except auto model.
- ASR on/off (except auto model).
- DPD regeneration
- T-bar gear selection control (auto model).
- **Left side combination stalk:** Windscreen wipers, washers and exhaust brake.
- **Right side combination stalk:** Turn signals, headlamps and cruise control.

INSTRUMENTATION

- Electronically driven speedometer and tachometer. Digital odometer with integrated dual tripmeter. Engine coolant temperature, fuel level and air pressure gauges.
- **Warning lamps:** Check engine, oil pressure, low coolant level, ABS, SRS airbag, alternator charge, service brakes, park brake, seat belt unfastened, low air pressure, low fuel level, cab lock.
- **Indicator lamps:** HSA (except auto model), warm up system, high beam, ASR (except auto model), exhaust brake, turn signals, cruise control.
- Multi information display. Shows service intervals, vehicle systems status, instantaneous and average fuel consumption, DPD bar chart, hourmeter, voltmeter, time/day/date and includes 40-120km/h adjustable vehicle speed warning.

OPTIONS AND GENUINE ACCESSORIES

Include the following (extra cost, request a brochure and further details from your Isuzu dealer):

Digital Audio Visual Entertainment unit:

- Telematics system.
- Supports up to four camera inputs, one camera and rear microphone input active when reversing. Reversing sensors.
- Tyre pressure monitoring system.
- Cables for full iPod / iPhone / iPad compatibility and connection to other external audio visual devices.

Other:

- Airbag compatible bullbar.
- Air deflector.

ISUZU CARE

Isuzu Care gives truck owners access to products and services including Roadside Assist, Service Agreements, Extended Care, Extended Isuzu Assist and the Isuzu Care Centre. Call 1800 035 640.

WEIGHTS (kg)

Models	Ratings*		Loading Limit* (at ground)		Cab Chassis Mass #		
	GVM	GCM	Front	Rear	Front	Rear	Total
FSR 140/120-260 AUTO SWB	14,000** / 12,000	20,000**	5,000	9,000	2,480	1,395	3,875
FSR 140/120-260 MWB	14,000 / 12,000	20,000	5,000	9,000	2,495	1,415	3,910
FSR 140/120-260 AUTO MWB	14,000** / 12,000	20,000**	5,000	9,000	2,515	1,410	3,925
FSR 140/120-260 LWB	14,000 / 12,000	20,000	5,000	9,000	2,560	1,445	4,005
FSR 140/120-260 AUTO LWB	14,000** / 12,000	20,000**	5,000	9,000	2,570	1,440	4,010
FSR 140/120-260 XLWB	14,000 / 12,000	20,000	5,000	9,000	2,615	1,505	4,120
FSR 140/120-260 AUTO XLWB	14,000** / 12,000	20,000**	5,000	9,000	2,625	1,500	4,125
FSD 140/120-260 LWB	14,000 / 12,000	20,000	5,000	9,000	2,550	1,480	4,030
FSD 140/120-260 LWB (AW)	14,000 / 12,000	20,000	5,000	9,000	2,530	1,425	3,955
FSD 140/120-260 AUTO LWB	14,000** / 12,000	20,000**	5,000	9,000	2,560	1,475	4,035
FSD 140/120-260 AUTO LWB (AW)	14,000** / 12,000	20,000**	5,000	9,000	2,540	1,420	3,960

* Vehicle ratings and front/rear weight limits are subject to government regulatory requirements and weight distribution analysis. Consult your Isuzu dealer to select the correct vehicle for your specific application.

** Pre-approved ratings as stated apply for general transport and distribution applications. For other applications approval from Allison is required. For example, GVM and GCM limits of 12,000kg apply for refuse application.

Cab chassis only as supplied and including 10 litres of fuel.

DIMENSIONS (mm)

Turn Circle (m)

Models	WB	OAL	FOH	ROH	EA	CE	RT	ORT	CH	FFA (unladen)	RFA (unladen)	RFH (unladen)	KERB TO KERB
FSR 140/120-260 AUTO SWB	3,790	6,555	1,170	1,595	2,770	4,490	1,705	2,240	2,665	745	885	940	13.6
FSR 140/120-260 MWB	4,360	7,255	1,170	1,725	3,375	5,190	1,705	2,240	2,665	755	885	925	15.6
FSR 140/120-260 LWB	5,560	9,155	1,170	2,425	4,575	7,090	1,705	2,240	2,665	755	885	925	19.9
FSR 140/120-260 XLWB	6,560	10,705	1,170	2,975	5,575	8,640	1,705	2,240	2,665	750	880	935	23.5
FSD 140/120-260 LWB	5,560	9,155	1,170	2,425	4,575	7,090	1,705	2,240	2,665	755	855	890	19.9

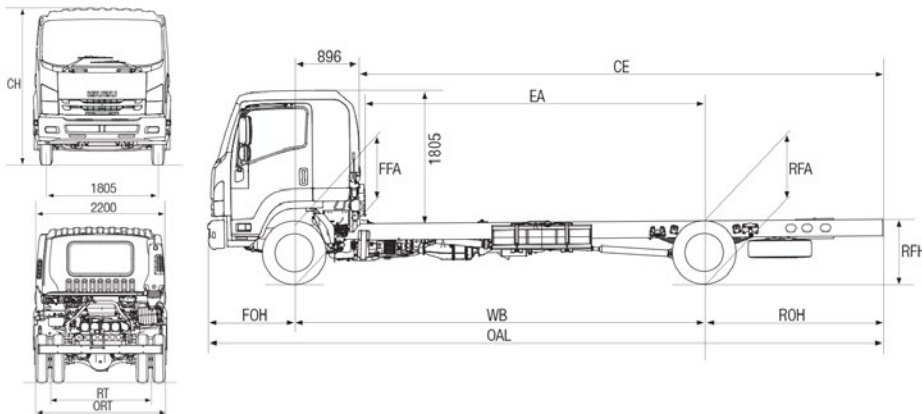

PERFORMANCE (calculated - typical paved road)

		Geared Speed* (top gear at peak power engine RPM)	Low Speed Gradeability (lowest forward gear assuming no wheel slip)	Engine Speed (top gear at 100km/h)
FSR 120-260	At 12,000 kg GVM	116 km/h @ 2,400 RPM	41%	2,330 RPM
FSR 120-260 AUTO	At 12,000 kg GVM	116 km/h @ 2,400 RPM	39%	2,360 RPM
FSR 140-260	At 14,000 kg GVM	116 km/h @ 2,400 RPM	35%	2,330 RPM
FSR 140-260 AUTO	At 14,000 kg GVM	116 km/h @ 2,400 RPM	33%	2,360 RPM

* Maximum speed achievable depends on vehicle frontal area as well as other factors. Consult your Isuzu dealer for more detailed information. Standard 100km/h speed limiter (mandatory on FSR 140-260 models).

ISUZU WARRANTIES

STANDARD¹

New Vehicle 3 years • 150,000km • 2,500 hours

Cab Perforation Corrosion 3 years • unlimited km

Isuzu Assist: 24 hour roadside assistance (3 years, unlimited km)*

EXTENDED CARE²

Extended Warranty: 5 years • 300,000km • 5,000 hours

Isuzu Assist: 24 hour roadside assistance (5 years, unlimited km)

ORDER CODES

Model	Code	Model	Code
FSR 140/120-260 AUTO SWB	FH-FSRCG-K18	FSR 140/120-260 AUTO XLWB	FH-FSRCG-P18
FSR 140/120-260 MWB	FH-FSRCG-B18	FSD 140/120-260 LWB	FH-FSDCG-D18
FSR 140/120-260 AUTO MWB	FH-FSRCG-L18	FSD 140/120-260 LWB (AW)	FH-FSDCG-D28
FSR 140/120-260 LWB	FH-FSRCG-D18	FSD 140/120-260 AUTO LWB	FH-FSDCG-N18
FSR 140/120-260 AUTO LWB	FH-FSRCG-N18	FSD 140/120-260 AUTO LWB (AW)	FH-FSDCG-N28
FSR 140/120-260 XLWB	FH-FSRCG-E18		

¹ Subject to the conditions outlined in the IAL New Vehicle Warranty, the Isuzu FSR and FSD models carry a standard factory warranty which covers the owner: (i) for the entire vehicle, for the first 36 months or 150,000 km or 2,500 hrs (whichever comes first), (ii) against cab perforation corrosion, for 36 months and unlimited kilometres. ² Extended Warranty as illustrated may be purchased to cover the owner against the failure of original components, but may exclude some components and expendable items such as oil, filters, etc. *Valid for three years from the date of new vehicle purchases. All Isuzu warranties are subject to mandatory prescribed terms under Australian Consumer law including customer guarantees. For more details visit the Isuzu website which explains Isuzu warranties in more detail, or alternatively contact your local dealer. All warranties commence from date of delivery.

ISUZU AUSTRALIA LIMITED ABN 97 006 962 572 ("IAL"). The information in this spec sheet was correct at time of printing, but all measurements, specifications and equipment are subject to change without notice. Some equipment may have been changed and/or is available at extra cost. IAL may make changes at any time without notice, in prices, colours, materials, equipment and models. IAL makes all reasonable attempts to ensure the availability of all vehicles and equipment. The information in this spec sheet is general in nature. Your Isuzu dealer can confirm all measurements, specifications and vehicle / equipment availability upon request. To the extent permitted by the law, IAL is not liable to any person as result of reliance on the content of this spec sheet.

We
share
the
load.

ISUZU
RELIABILITY IS EVERYTHING